

BÖLLHOFF

IMTEC®

Thread inserts for in-moulding processes



CARDINAL
COMPONENTS · INC

Request your quote with Rivet Nut USA (an operating division of Cardinal Components, Inc.)
Cardinal Components, Inc. is your authorized preferred specialty fastener distributor.

Sales@RivetNutUSA.com

ISO 9001 CERTIFIED
www.RivetNutUSA.com

(800) 236-3200

We are a partner of the ReLei research and development project



Fabrication and recycling strategies for electromobility to recycle lightweight structures in fibre-reinforced composite hybrid design

This research and development project was funded by the German Federal Ministry of Education and Research within the conceptual framework „Innovations for the production, service and work of tomorrow“ (reference number 02PJ2800–02PJ2808) as well as by the Energy and Climate fund and supervised by the project sponsor Projektträger Karlsruhe (PTKA).

Funded by



Supervised by

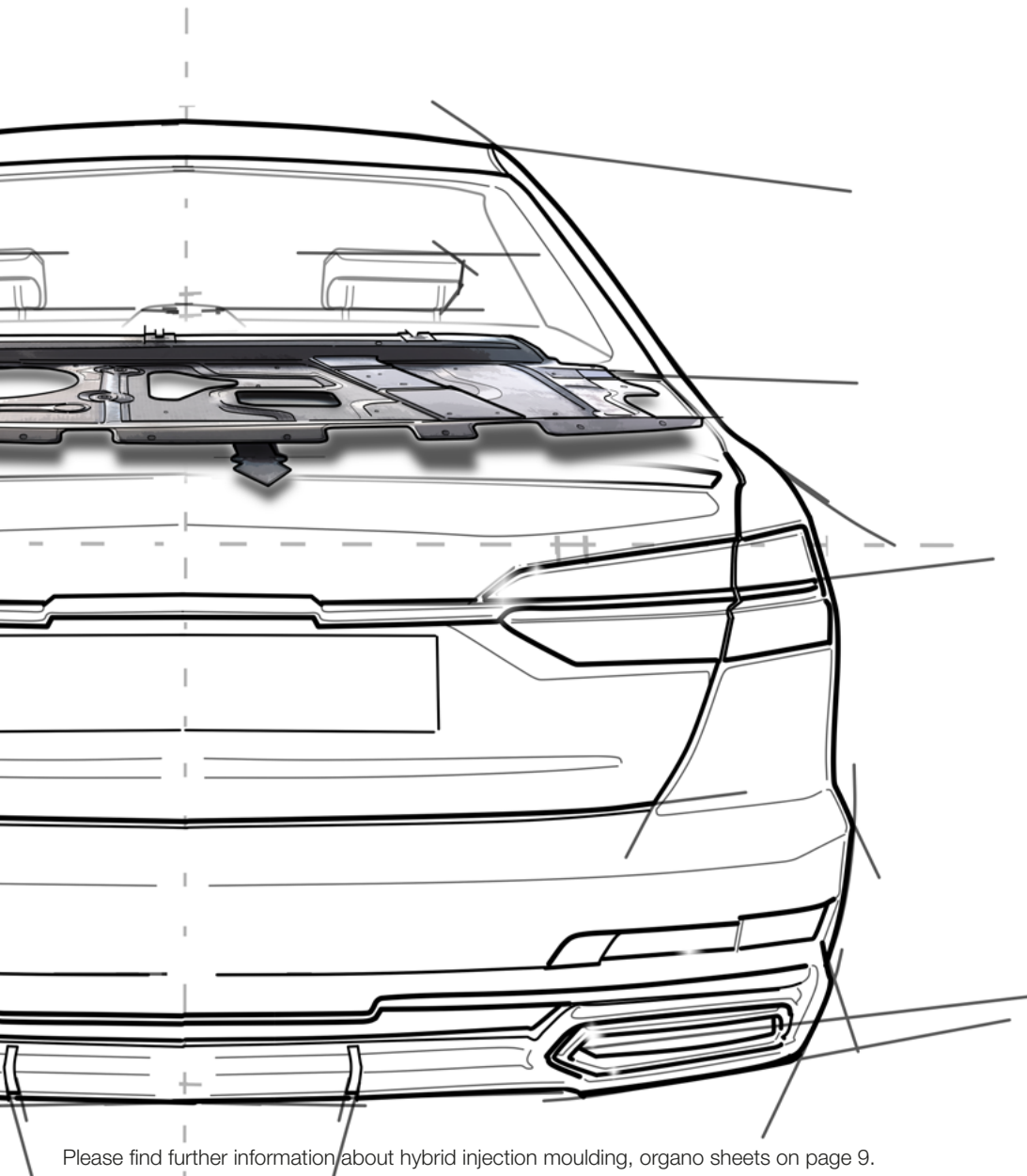

Please find further information about hybrid injection moulding, organo sheets on page 9.

Partners production methods



Partners materials processing



Partners disassembly and joining technology



Associated partners



Sales@RivetNutUSA.com

ISO 9001 CERTIFIED
www.RivetNutUSA.com

Request your quote with Rivet Nut USA (an operating division of Cardinal Components, Inc.)
Cardinal Components, Inc. is your authorized preferred specialty fastener distributor.

(800) 236-3200

Table of content

In-moulding and after-moulding – the processes 4

IMTEC® thread inserts – product types 6

IMTEC® CO 6

IMTEC® CF 6

IMTEC® thread inserts – overview of the processing methods 7

IMTEC® thread inserts – the different processing methods 8

 Plastic injection moulding 8

 Hybrid injection moulding – e.g. organo sheets, tapes 9

 Aluminium die casting 10

Technical data 12

Fields of application 14

 **Info-Point** 15

This icon indicates further information in the form of a brochure and/or video.

In-moulding and after-moulding – the processes

The continuing further technological development has led to constantly increasing requirements for components and their applications. Often, they are so high that one material alone cannot meet them. Therefore, it is of particular interest to combine the specific advantages of different materials.

As a joining technology expert, Böllhoff recognised this beneficial synergy effect very early on and in addition to the well-known AMTEC® after-moulding technology, which has been tried and tested for years, also offers IMTEC® thread inserts for in-moulding processes.

In-moulding

Suited for thermoplastics and thermosets

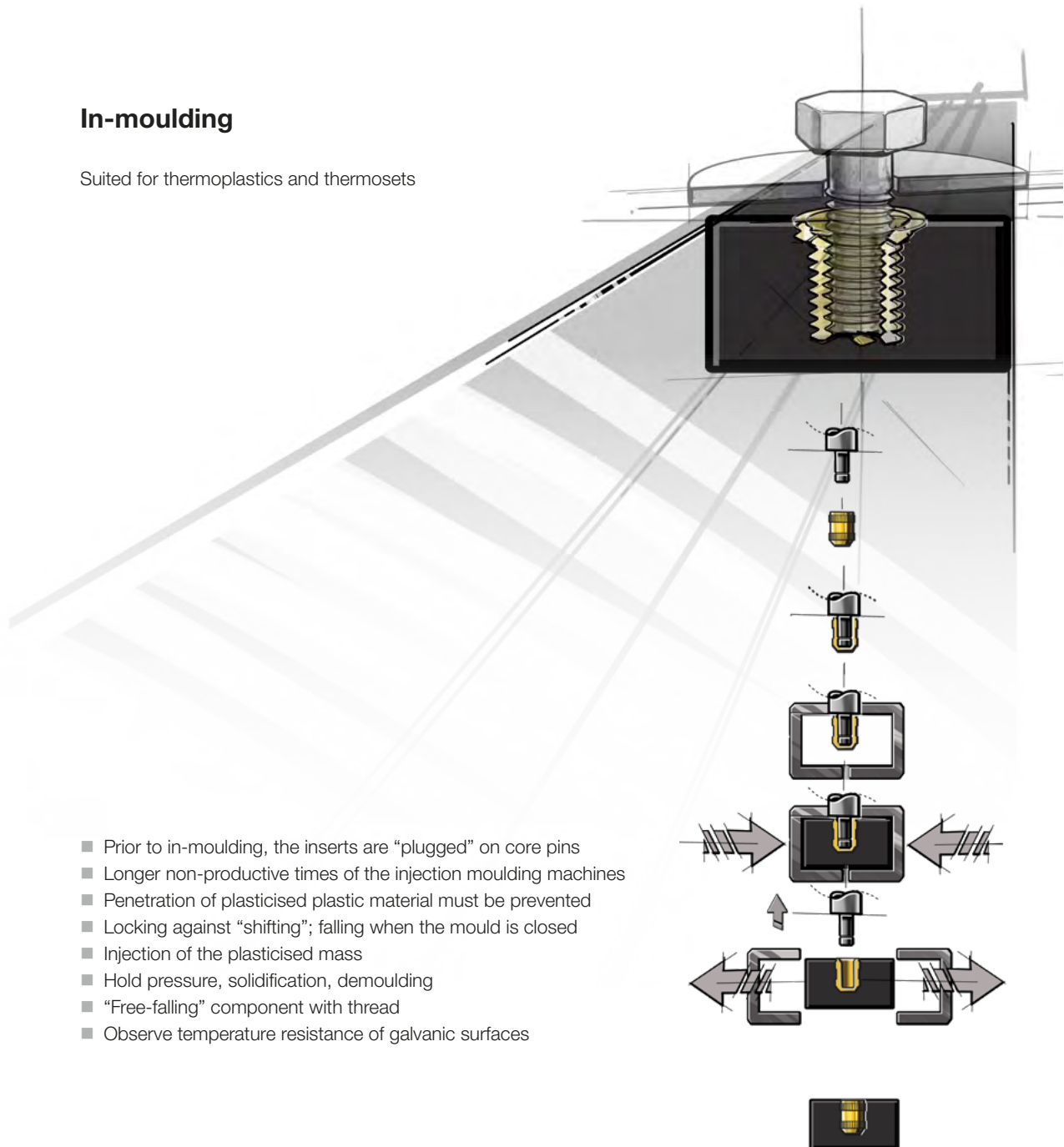

- Prior to in-moulding, the inserts are “plugged” on core pins
- Longer non-productive times of the injection moulding machines
- Penetration of plasticised plastic material must be prevented
- Locking against “shifting”; falling when the mould is closed
- Injection of the plasticised mass
- Hold pressure, solidification, demoulding
- “Free-falling” component with thread
- Observe temperature resistance of galvanic surfaces

Sales@RivetNutUSA.com

ISO 9001 CERTIFIED
www.RivetNutUSA.com

(800) 236-3200

In-moulding and after-moulding – the processes

There is a general decision you have to make: Mould in inserts or embed later?

Basically, both principles meet all technical requirements in a similar way and cause comparable costs with respect to the used fasteners. Based on experience and provided equipment, you as the user decide which joining technology is better suited for your production environment.

However, before we start to take a closer look at the IMTEC® technology, we invite you on a short illustrated excursion into the differentiation between the two joining technologies.

After-moulding

Suited for thermoplastics and thermosets

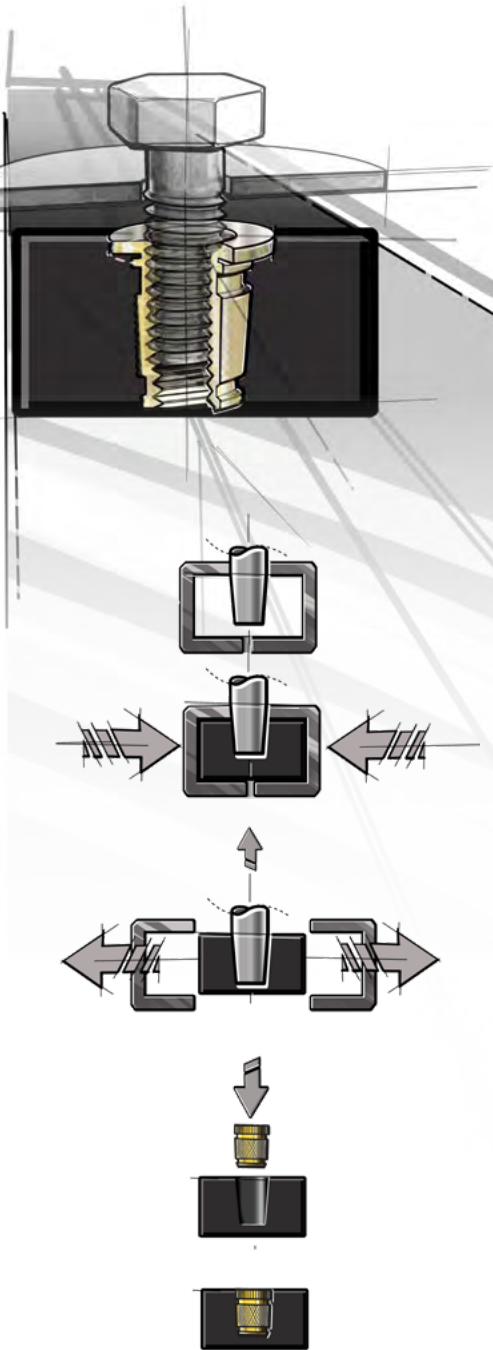

- Produce a mounting hole with a core pin (cone 1° minimum)
- Shorter non-productive times of the injection moulding machine during the process
- Injection of the plasticised mass
- Hold pressure, solidification, demoulding
- Usually small tolerances (≤ 0.1 mm)
- Subsequent joining process possibly investment in tool and worker; generally parallel (machine operator)
- Embedding only in OK parts
- Use of O-rings possible

Sales@RivetNutUSA.com

Request your quote with Rivet Nut USA (an operating division of Cardinal Components, Inc.)
Cardinal Components, Inc. is your authorized preferred specialty fastener distributor.

ISO 9001 CERTIFIED
www.RivetNutUSA.com
(800) 236-3200

IMTEC® thread inserts – product types

Böllhoff offers with the IMTEC® moulded inserts two innovative product developments for in-moulding of metal threads in components of polymer, composite or light-metal components*:



IMTEC® CO – Particularly for creation of blind hole threads



The IMTEC® CO thread insert for in-moulding is an asymmetric rolled stainless steel A2 (option A4) wire which is mainly used for customer components with blind hole threads. That wire is coiled to form a fixed bushing with at least one flange-type extension.

In the forming process, the fasteners are also sufficiently magnetised and can be placed on magnetic core pins manually or by means of handling systems.

Your advantages

- Maximum usable thread length
- Corrosion and acid resistance
- Increased technical cleanliness (residual dirt minimisation)
- High extraction force due to an optimisation of flank covering in plastics
- Weight reduction of the component



IMTEC® CF – Particularly for creation of through hole threads



The IMTEC® CF thread inserts with „double flange“ are produced from steel by cold forming. The in-moulding technology requires particularly accurate thread inserts. The deformation area on the IMTEC® CF allows precisely adjusting the length of the thread insert according to the mould dimension. Upon closing, the parts of the mould compress the IMTEC® CF and precisely adjust the length of the component ($L \pm 0.15$ mm). IMTEC® CF is primarily intended for components with through hole threads.

Your advantages

- Very large flange diameters possible
- Deformation area for length adjustment of the insert; close length tolerances $< L \pm 0.05$ mm
- Torque resistance by hexagonal design or knurls
- Pull out resistance by providing significant under cuts
- No metal-cutting operation
- Also feasible as compression limiter

* Cast aluminium, see page 10

IMTEC® thread inserts – overview of the processing methods

Here you find an overview of the IMTEC® thread technology relating to different processing methods.



Processing methods	IMTEC® CO	IMTEC® CF
Plastic injection moulding	✓	✓
Hybrid injection moulding – e.g. organo sheets, tapes, ...	✓	✓
Cast aluminium	✓	✗
Compression moulding (SMC, GMT)	✓	✓

Choose the perfect innovative principle of IMTEC® thread technology for your requirements.

Application area

Open end	✗	++
Close end	++	+
Minimum remaining wall thickness	++	+
Large through hole in the screwed on parts; very soft counter parts	+	++
Functionality as compression limiter	✗	++

Shaping of thread inserts

Big flange diameter	✗	++
Flange as sort key	++	++

Mechanical Properties

Axial tensile force	++	++
Push-out force	++	++
Torque resistance	++	++
Corrosion resistance	++	+

Process quality

Non-cutting guarantee	++	+
100% control	++	++
Automatic feeding process	+	++

✗ not suited | + well suited | ++ very well suited

Sales@RivetNutUSA.com

ISO 9001 CERTIFIED
www.RivetNutUSA.com
(800) 236-3200

Request your quote with Rivet Nut USA (an operating division of Cardinal Components, Inc.)
 Cardinal Components, Inc. is your authorized preferred specialty fastener distributor.

IMTEC® thread inserts – the different processing methods

Plastic injection moulding

IMTEC® is used for forming, particularly in injection moulding (here in-moulding technology).

For the manufacture of plastics-metal components (hybrid parts), a system composed of injection moulding machine, injection mould and optionally automation technology is required.

The injection mould preferably made of steel consists of several components and different single parts. Only the core pins of the injection moulds have to be geometrically adapted to the IMTEC® moulded inserts to achieve great accuracy and reproducibility.

The thread inserts are placed into the mould manually or by means of a handling system (figure 1, example of a plastic handle). Due to the forming process, the thread inserts are also sufficiently magnetised and can therefore be securely placed on magnetic core pins.

In the next step, the mould is closed (figure 2) and a precisely measured amount of the plasticised plastic material is injected into the cavities of the injection mould under high pressure and at high speed (figure 3). Until the liquid core of the moulding material has cooled down and become solid, the component remains in the mould. After the end of the residual cooling time, the clamping unit opens the mould and the component is ejected (figure 4).



IMTEC® CO installation



1) Placing on core pin of the injection mould



2) Mould closing

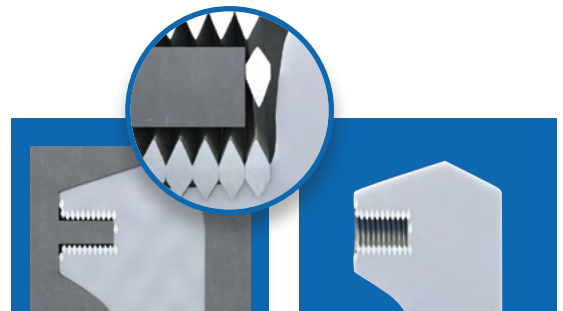

3) Injection of plasticised material into the mould



4) Component after ejection

IMTEC® CF installation



1) Placing on core pin of the injection mould



2) Mould closing



3) Injection of plasticised material into the mould

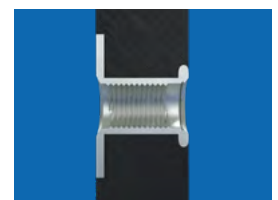

4) Component after ejection

IMTEC® thread inserts – the different processing methods

Hybrid injection moulding – e.g. organo sheets, tapes

An important aspect about lightweight construction concepts are alternative materials. With the low material density and very good processing and design options, the significance of plastic-based lightweight construction concepts is continually growing. Organo sheets relate to the main focus “fibre-reinforced plastics”.

Organo sheets are composite materials in which a non-crimp fabric consisting of glass fibre, carbon, aramid or a hybrid is embedded in a thermoplastic polyamide or polypropylene layer. “Organo” refers to the organic matrix, the thermoplastic, while “sheets” indicates that they can substitute metal sheets. The combination of organo sheets and IMTEC® thread inserts allows to mould functional elements directly to the component with high process reliability (functional integration).

Process sequence:

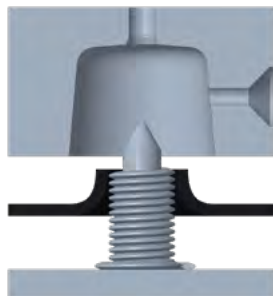

- The IMTEC® CO is held by the core pin.
- Piercing the pre-heated and thus flexible organo sheet (PA matrix).

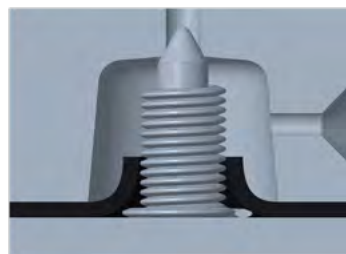

Mould closing

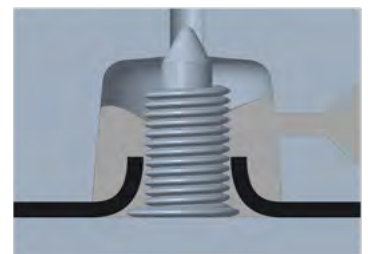

The thermoplastic matrix must harmonise with the material of the moulded-on functional elements.



Holding pressure and cooling



Opening the mould and demoulding



The result:

An IMTEC® CO thread insert integrated into a plastic dome which was moulded to an organo sheet with thermoplastic matrix with quasi material closure.

Your advantages

- Functional integration
- Shorter process times
- No rework

Advantages of organo sheets

- High strength and stiffness
- Weight reduction
- Process-reliable
- Reproducible

Sales@RivetNutUSA.com

ISO 9001 CERTIFIED
www.RivetNutUSA.com

Request your quote with Rivet Nut USA (an operating division of Cardinal Components, Inc.)
 Cardinal Components, Inc. is your authorized preferred specialty fastener distributor.

(800) 236-3200

IMTEC® thread inserts – the different processing methods

Aluminium die casting

Since the IMTEC® CO was successfully used for plastic injection moulding, the demand arose to test to expand the field of use to cast aluminium. Here we consider two manufacturing processes in which liquid or pasty aluminium is cast or forced into pre-heated steel moulds (tools or dies) under (high) pressure.

There are the following challenges to thread forming in light alloys:

- Mass melting temperature ≥ 660 °C
- Extremely low viscosity
- Different casting methods:
 - Low-pressure casting (gravity casting, permanent mould casting ...)
 - Die casting (10–200 MPa; 12 m/s)
- Thermal damage to surfaces and thread inserts (effects of corrosion)



1. Low-pressure die casting

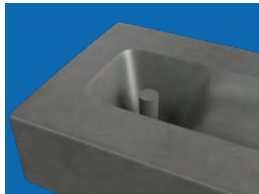

Permanent metal mould.

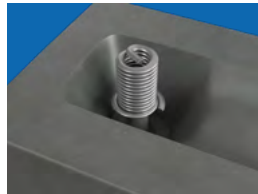

Plugging the IMTEC® CO on a smooth core pin.



Casting the liquid melted aluminium into the transfer chamber without pressure using dosing machines or manually from a ladle.

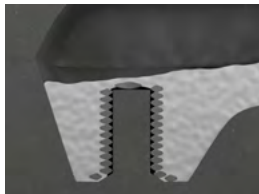

The liquid melted aluminium fills the mould and encloses the IMTEC® CO without flowing into the internal thread.

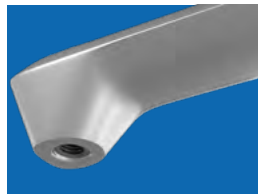

After the solidifying melt has cooled, a wear-free, high-strength thread has been formed in your high-quality light-metal components.

IMTEC® thread inserts – the different processing methods



2. Die casting

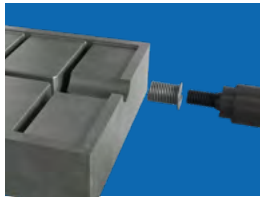

Steel mould, IMTEC® CO and automatic spindle device.



Spun on IMTEC® CO



The liquid melted aluminium forced in under high pressure fills the mould and encloses the IMTEC® CO on the spindle core without flowing into the internal thread.



After the solidifying melt has cooled, a wear-free, high-strength thread has also in this case been formed in your high-quality light-metal components.

For the use of IMTEC® CO, smooth core pins are sufficient for the low-pressure method, whereas methods involving higher compressive forces require spindle cores (= threads) to prevent the liquid aluminium from flowing into the internal thread.

The validation tests with automatic spindle devices were passed on the OEM level.

Sales@RivetNutUSA.com

ISO 9001 CERTIFIED
www.RivetNutUSA.com

Request your quote with Rivet Nut USA (an operating division of Cardinal Components, Inc.)
Cardinal Components, Inc. is your authorized preferred specialty fastener distributor.

(800) 236-3200

IMTEC® CO – technical data

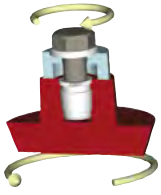

Jack out torque MA [Nm]

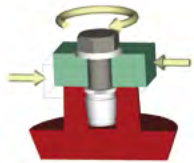

Torque MR [Nm]

**Torque values
M 4 to M 8**

	M 4	M 5	M 6	M 8
PP MA [Nm]	–	5.8	6.4	–
PA MA [Nm]	–	8.6	9.5	–
PP MR [Nm]	4.9	7.9	14.9	27.5
PA MR [Nm]	6.7	11.2	21.5	49.5

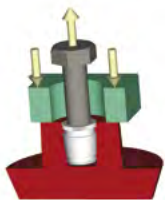
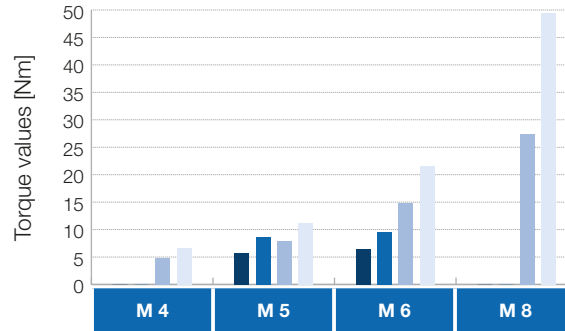

Pull-out loads FA [kN]

**Pull-out values
M 5 and M 6**

	M 6	M 8
PP FA [kN]	6.5	7.9
PA FA [kN]	8.5	9.9

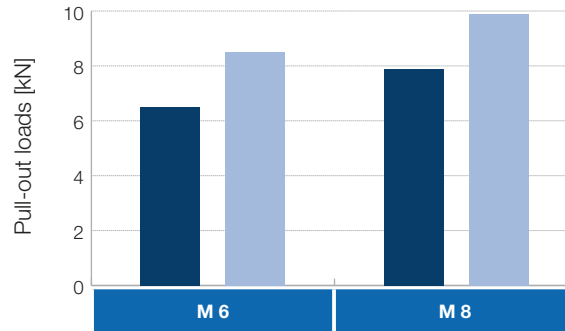

Dimension

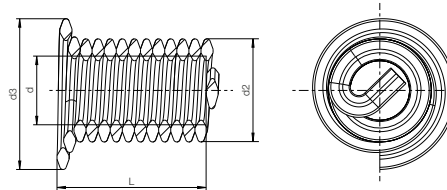

Size d	Type	L + 0.5 mm	d2 ± 0.2 mm	d3 - 0.5 mm	Core pin Ø mm Guideline / h6
M 4	4531 004 0007	7.3	5.50	7.8	3.30
M 4	4531 004 0008	8.5	5.50	7.8	3.30
M 5	4531 005 0010	10.0	7.00	9.2	4.15
M 5	4531 005 0122	12.2	7.00	9.2	4.15
M 6	4531 006 0012	12.3	8.50	12.5	5.05
M 8	4531 008 0016	16.3	11.15	15.5	6.65
M 8	4531 008 0024	24.2	11.15	15.5	6.70
M 10	4531 010 0020	20.6	13.00	19.0	8.50
M 10 x 1.25	4531 010 9020	20.6	13.15	19.0	8.65
M 12 x 1.5	4531 012 4024	24.6	15.20	19.4	10.55
M 12 x 1.25	4531 012 9024	24.6	15.15	21.4	10.65

Remarks:

Dry film lubrication is recommended. Using stainless steel screws potentially cold shuts can occur as a result of the material of the IMTEC® CO inserts A2 (material specification 1.4301/1.4310; option A4 material specification 1.4375). Magnetized core pins can be applied. Core pin: Modification according to the specific application.

Sales@RivetNutUSA.com

ISO 9001 CERTIFIED
www.RivetNutUSA.com

(800) 236-3200

Request your quote with Rivet Nut USA (an operating division of Cardinal Components, Inc.)
Cardinal Components, Inc. is your authorized preferred specialty fastener distributor.

IMTEC® CF – technical data

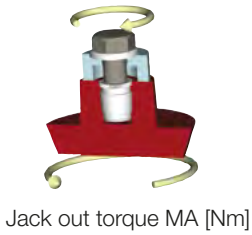

**Torque values
M 6 to M 8**

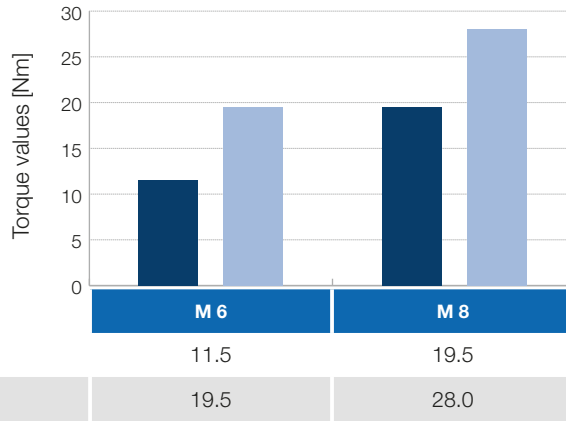

PP MA [Nm]	11.5	19.5
PA MA [Nm]	19.5	28.0

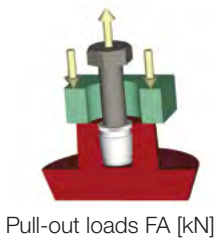

**Pull-out values
M 6 and M 8**

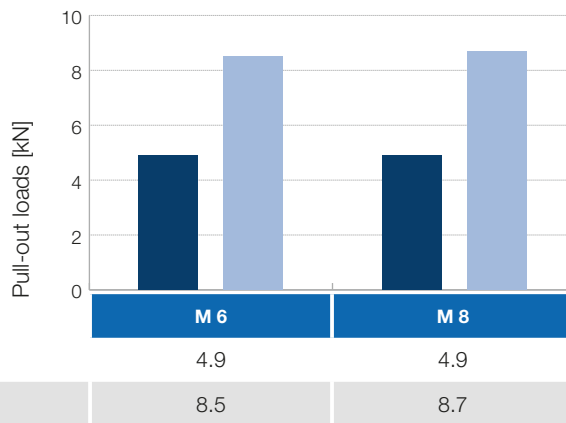

PP FA [kN]	4.9	4.9
PA FA [kN]	8.5	8.7

Dimension

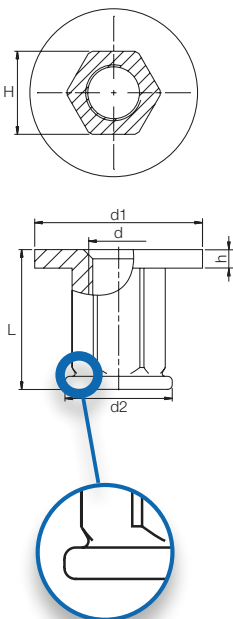

Size d	Type	L ± 0.15 mm	d2 ± 0.4 mm	d1 ± 0.2 mm	h mm	H mm
M 5	2002 105 0002	9.00	9.9	12.0	1.5	7.9
M 5	2002 105 0003	11.00	9.9	16.0	1.5	7.9
M 6	2002 106 0706	15.00	11.5	18.0	2.0	8.9
M 6	2002 106 0711	14.00	11.0	13.0	1.5	8.9
M 6	2002 106 0713	15.00	11.5	18.0	2.0	8.9
M 6	2002 106 0714	21.00	11.0	13.0	1.5	8.9
M 6	2002 106 0715	10.00	11.0	13.0	1.5	8.9
M 6	2002 106 0718	14.00	11.0	13.0	1.5	8.9
M 8	2002 108 0687	18.15	13.5	15.0	2.0	10.9
M 8	2002 108 0688	18.15	13.5	15.0	2.0	10.9
M 8	2002 108 0689	13.00	13.5	16.0	1.5	10.9

Standard version: steel, galvanised

Closed end versions and different diameters (M 4 to M 12) are available on request:

- Length of component: 10 to 25 mm for M 6 and 10 to 30 mm for M 8
- Tolerance concerning the length: ± 0.15 mm
- Head diameter: 12 to 20 mm

Tooling costs to be considered.

Deformation area which allows length adjustment of the insert according the dimension of the mould.

IMTEC® thread inserts – fields of application

The IMTEC® inserts are used in many fields of applications, such as:

- Medical technology
- Automotive industry
- Plastics technology
- Electrics, electronics
- Fluid technology

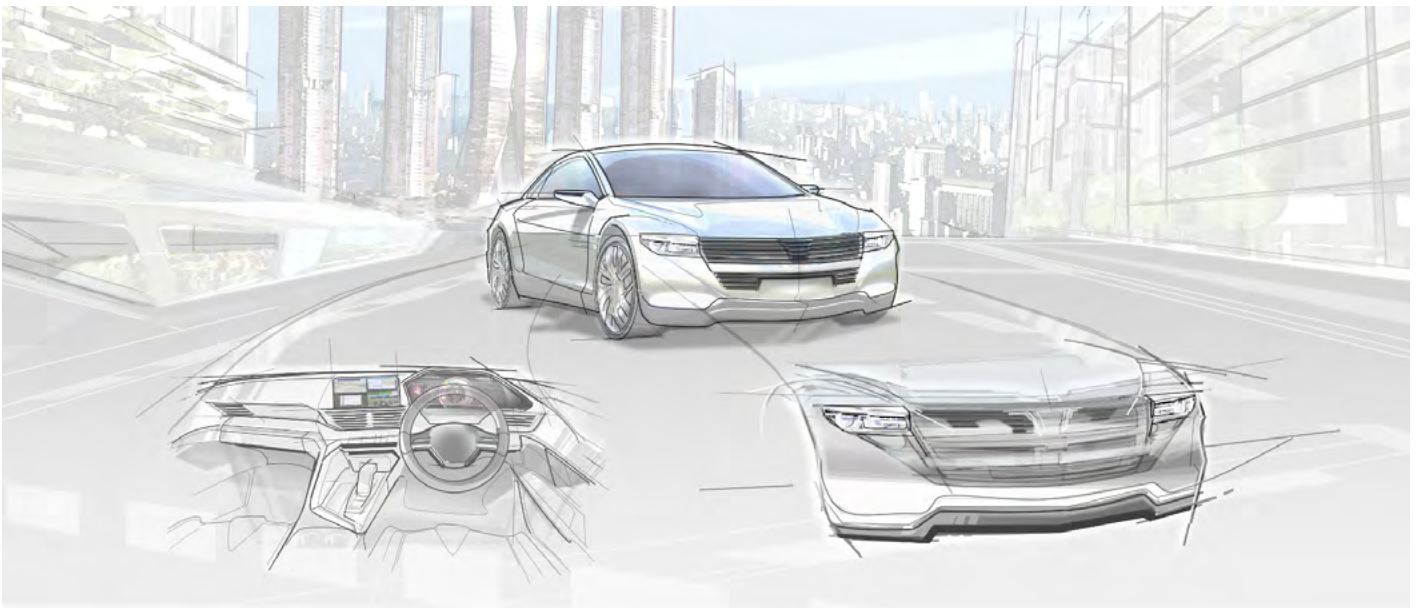
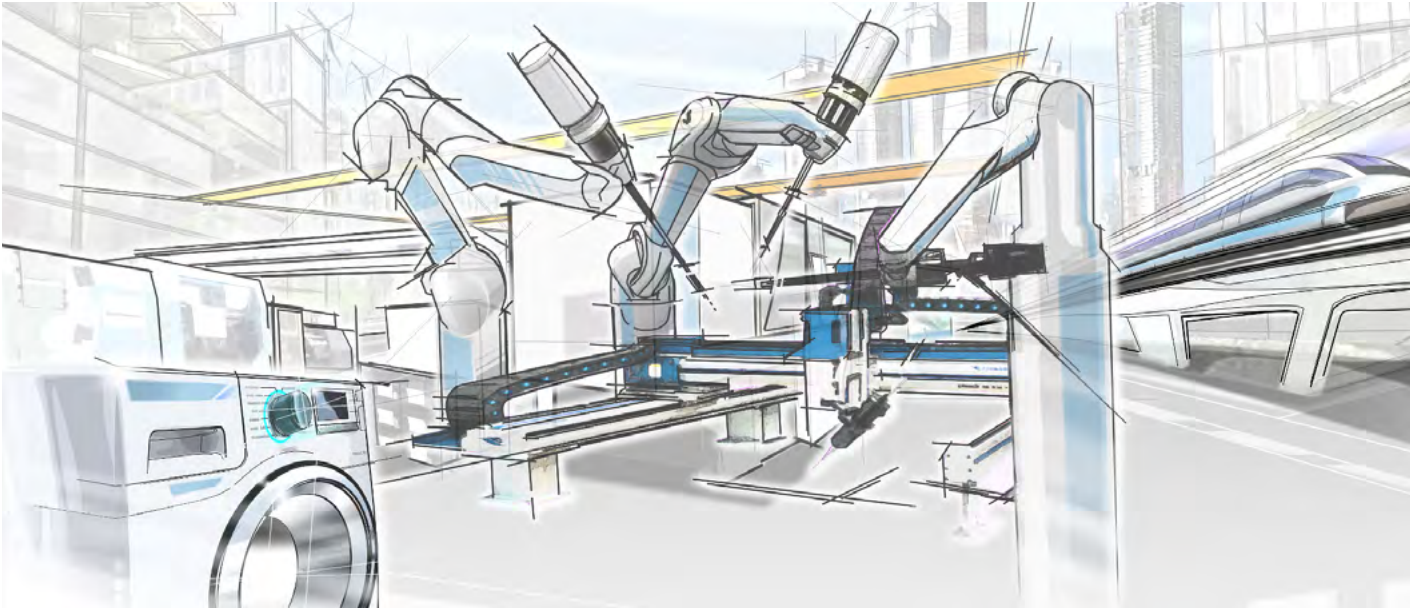

We are pleased to develop and produce your customised thread inserts and applications.

Sales@RivetNutUSA.com

Request your quote with Rivet Nut USA (an operating division of Cardinal Components, Inc.)
Cardinal Components, Inc. is your authorized preferred specialty fastener distributor.

ISO 9001 CERTIFIED
www.RivetNutUSA.com
(800) 236-3200

Product catalogues



IMTEC®
Thread inserts for in-moulding processes
<https://www.boellhoff.com/en/pdf/imtec>



AMTEC®
Precision thread inserts for after-moulding joining in plastic components
<https://www.boellhoff.com/en/pdf/amtec>

Videos



IMTEC® CO
Thread inserts for in-moulding processes
<https://www.boellhoff.com/video/imtec-co>



IMTEC® CF
Thread inserts for in-moulding processes
<https://www.boellhoff.com/video/imtec-cf>



IMTEC® CO
for aluminium die casting
<https://www.boellhoff.com/video/imtec-for-cast-aluminium>



AMTEC® HITSERT® 2
Thread insert with sealing ring
<https://www.boellhoff.com/video/hitsert2-with-sealing-ring>



AMTEC® QUICKSERT® Hex
Efficient thread inserts for self-tapping insertion in polymers
<https://www.boellhoff.com/video/quicksert-hex>

BÖLLHOFF



Böllhoff Group

Innovative partner for joining technology with assembly and logistics solutions.

Find your local partner at www.boellhoff.com or contact us at fat@boellhoff.com.

Passion for successful joining.

Sales@RivetNutUSA.com

*Request your quote with Rivet Nut USA (an operating division of Cardinal Components, Inc.)
Cardinal Components, Inc. is your authorized preferred specialty fastener distributor.*

ISO 9001 CERTIFIED
www.RivetNutUSA.com

(800) 236-3200